

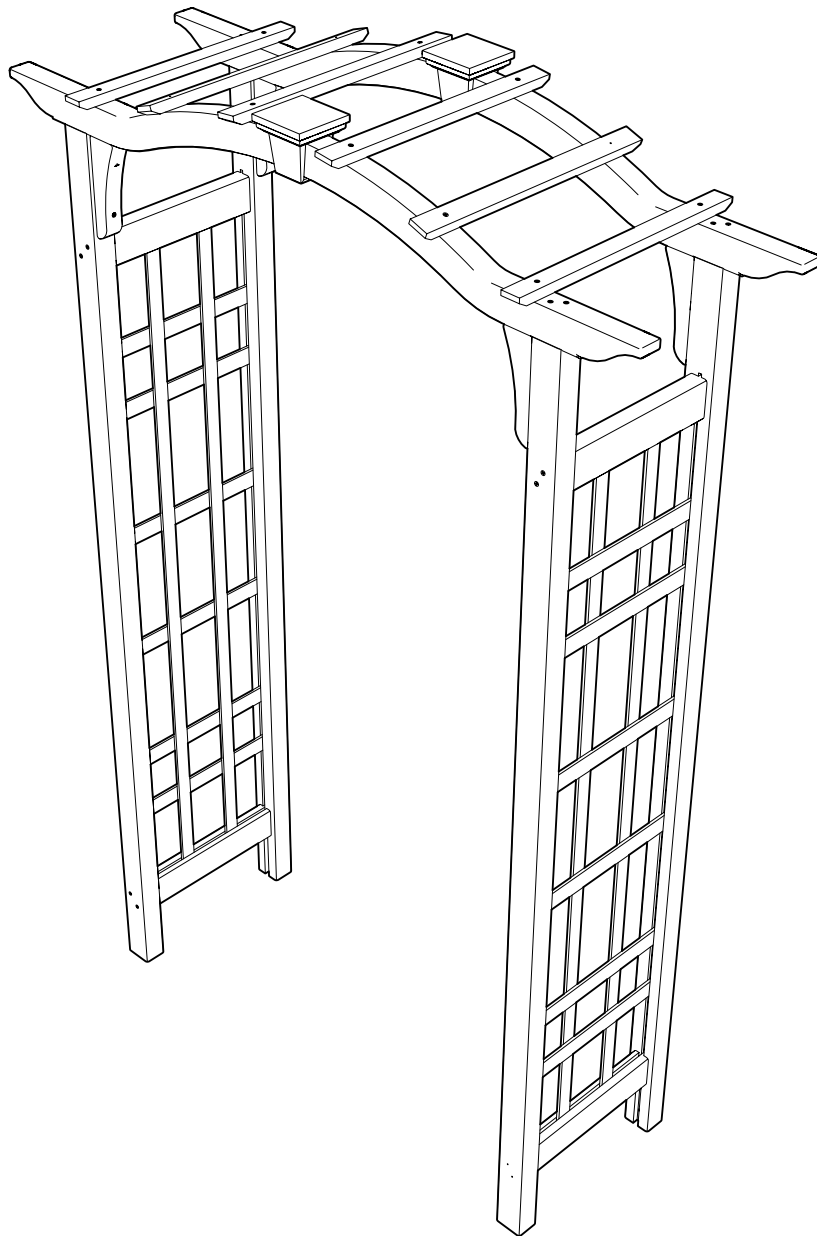

**ASSEMBLY
GUIDE**

Westwood Arbor

VA68890



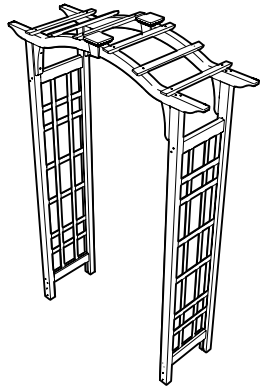

— X —

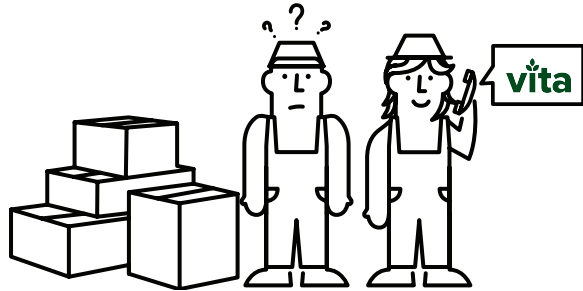
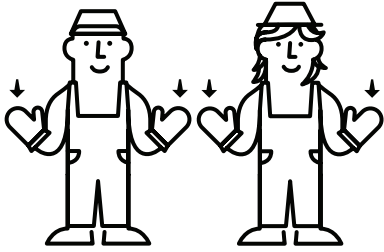
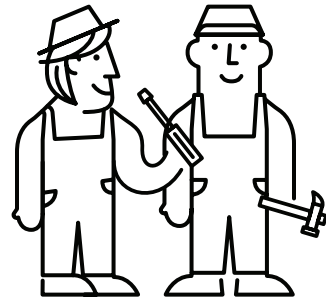

 **1-800-282-9346**



HELLO@WEAREVITA.COM



WWW.WEAREVITA.COM



8AM - 5PM EST



IN THIS GUIDE

PARTS LIST	4
TOOLS YOU WILL NEED - PRODUCT DIMENSIONS	5
STEP 1 AND 2	6
STEP 3 AND 4	7
STEP 5 AND 6 (TEMPORARY INSTALLATION)	8
STEP 7 (PERMANENT INSTALLATION)	9

PARTS LIST

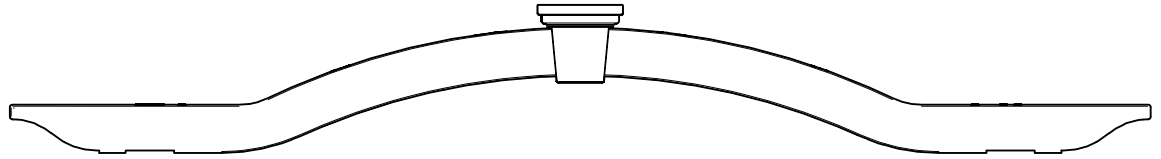

PREASSEMBLED ARCH - 12009 - X2

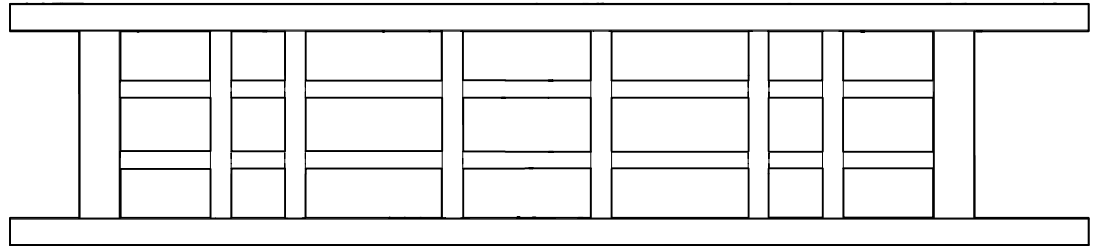

PRE-ASSEMBLED SIDE PANEL - 12008 - X2

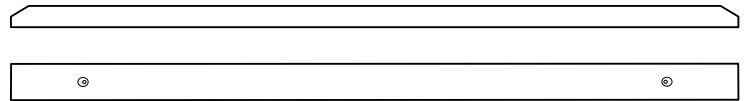

ARCH RAFTER - 12007 - X6

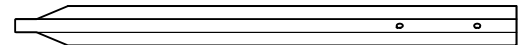

METAL GROUND STAKES - 12006 - X4

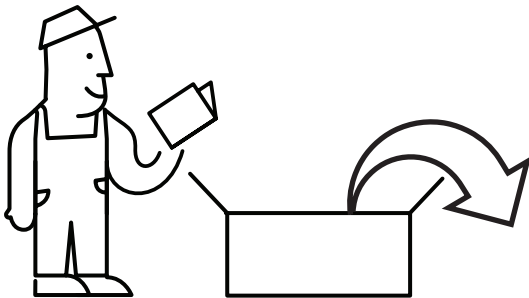

BRACES - 12005 - X4

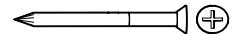

SCREW A - 20037- 1 1/2IN (3.8CM) - X12 - TO ATTACH RAFTERS TO ARCH

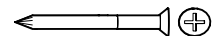

SCREW B - 20064 - 1 1/4IN (3.18CM) - X8 - ATTACH GROUND STAKES TO POSTS

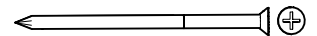

SCREW C - 20068 - 2IN (5CM) - X4 - TO ATTACH THE FLAT PART OF THE BRACES TO ARBOR POSTS

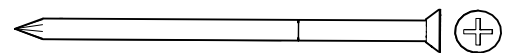

SCREW D - 20069 - 3IN (7.6CM) - X4 - TO ATTACH THE SWOOP PART OF THE BRACE TO ARBOR

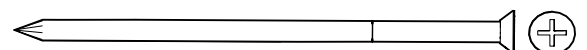

SCREW E - 20070 - 3 1/2IN (9CM) - X8 - TO ATTACH SWOOP PART OF ARCHS TO ARBOR POSTS

TOOLS YOU WILL NEED

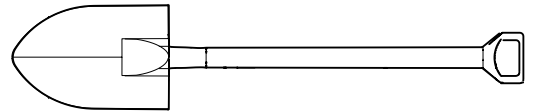
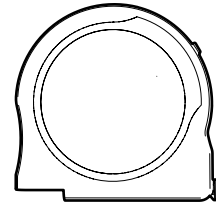
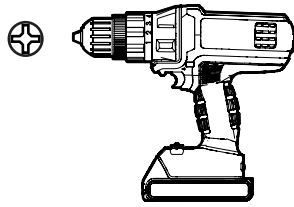
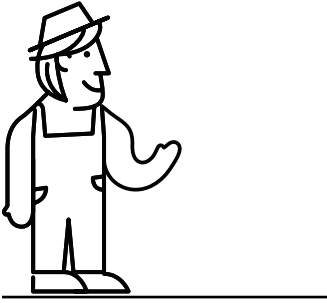

PRODUCT DIMENSIONS

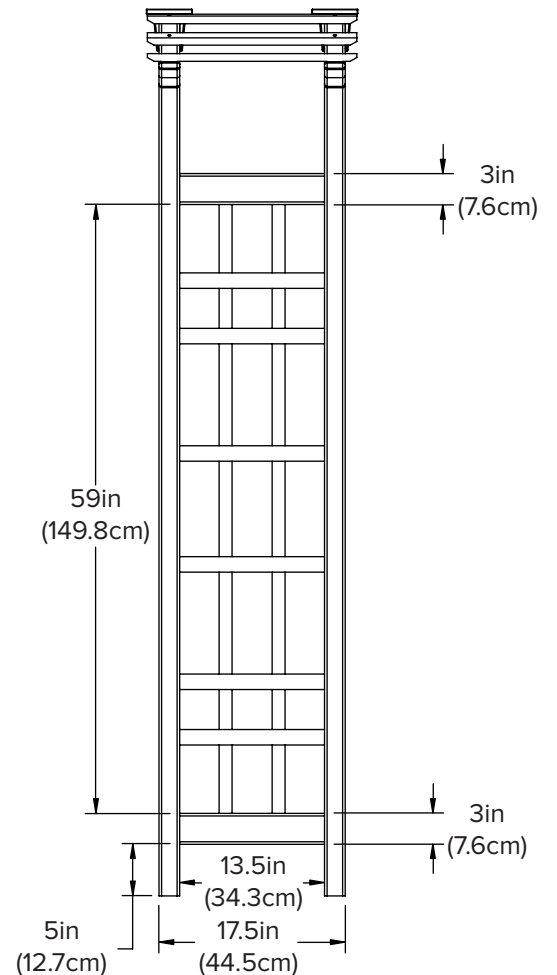
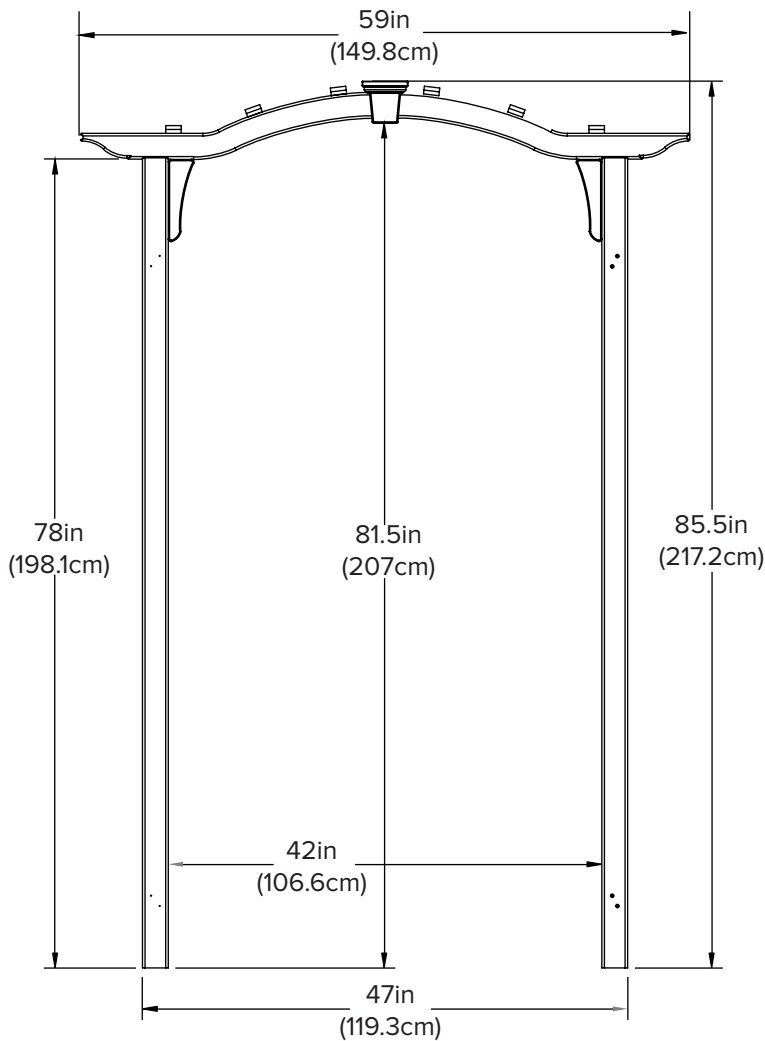

1

12009 - X2



12008 - X2

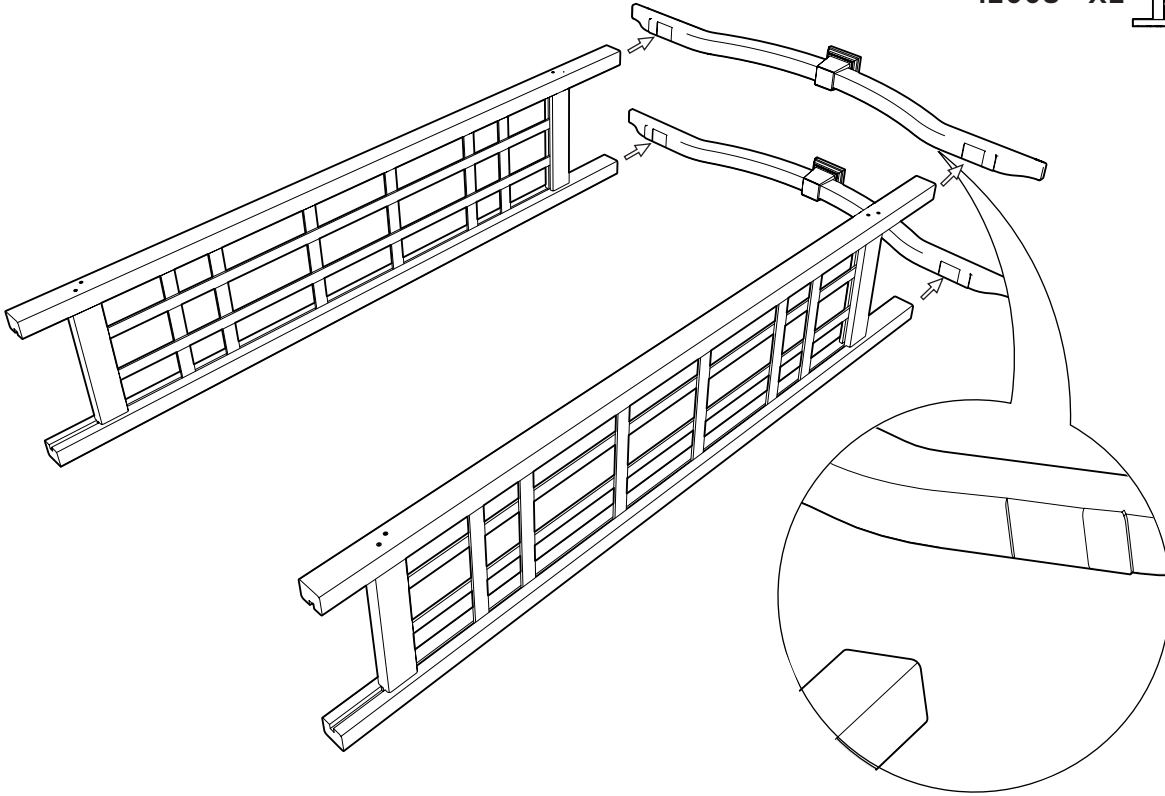
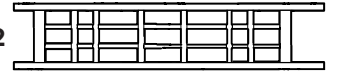

2

20070 - X8

(E)

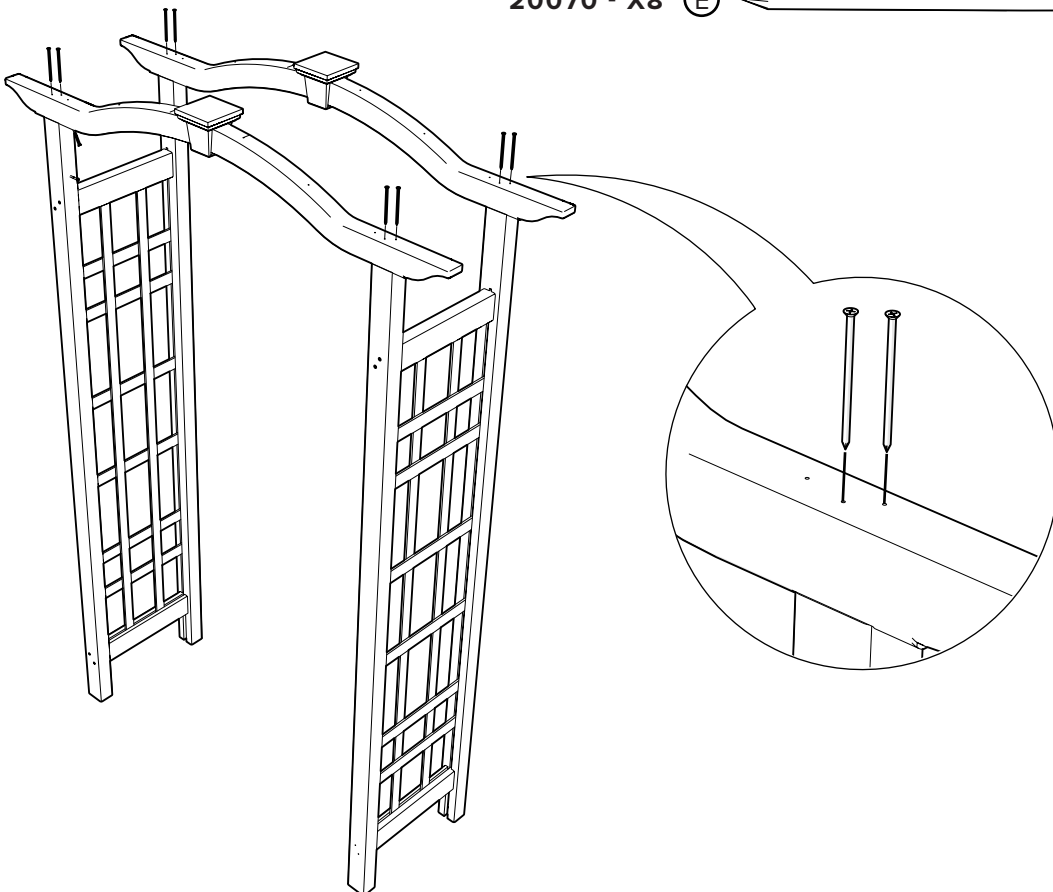
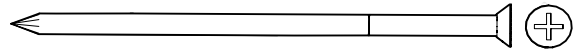

3

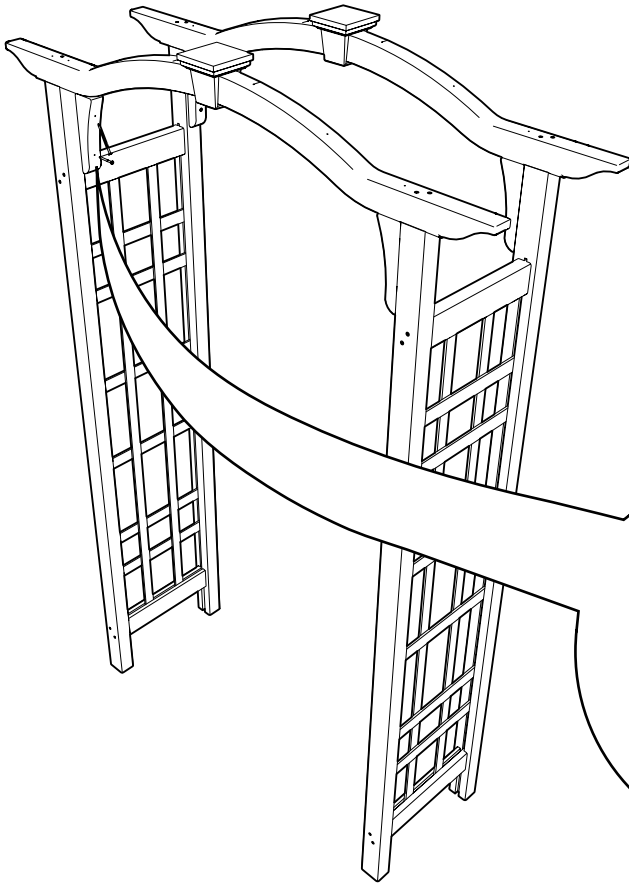

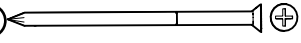
20068 - X4 (C) 

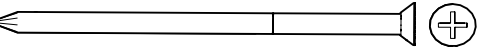
20069 - X4 (D) 

12005 - X4 

Brace should be in the center of the post.
Screw (D) in first, then (C)

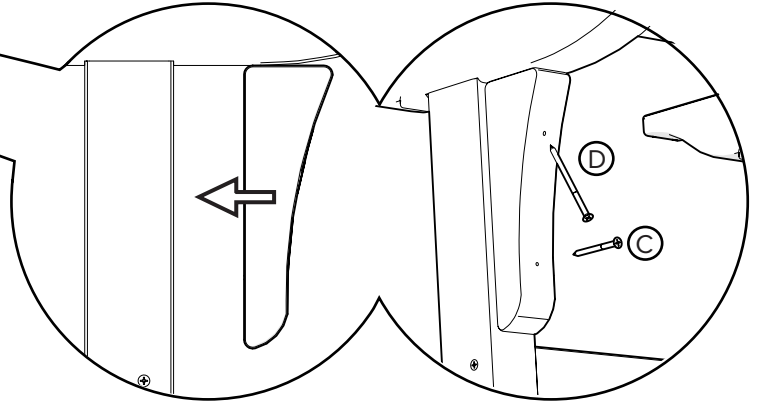

4

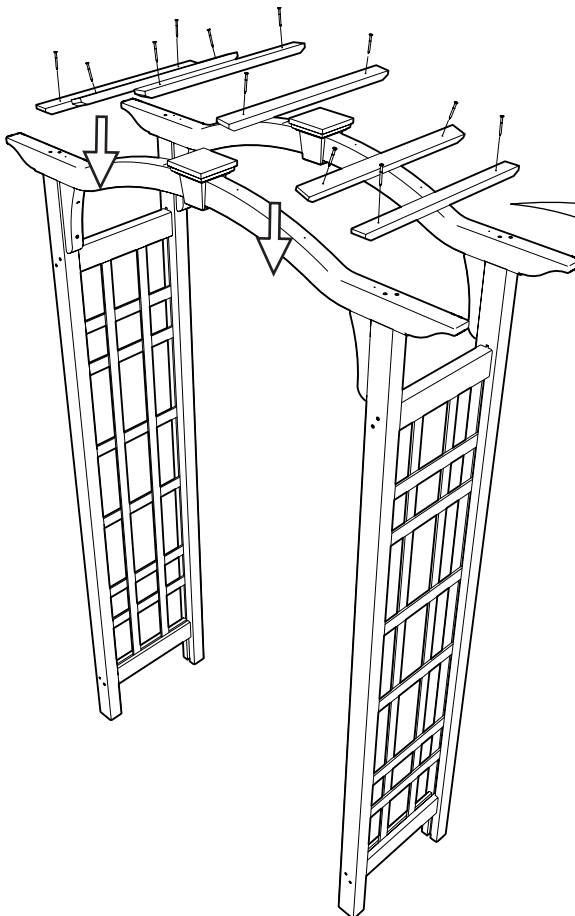

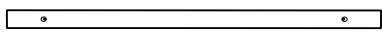

20037 - X12 (A) 

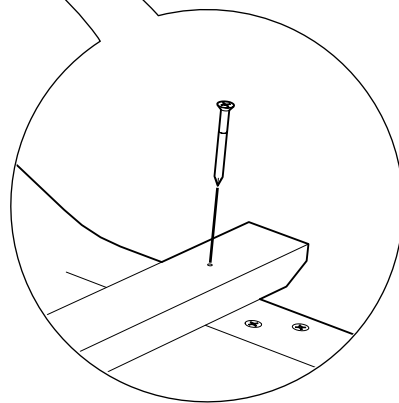
12007 - X6 



5

20064 - X8  
12006 - x4 

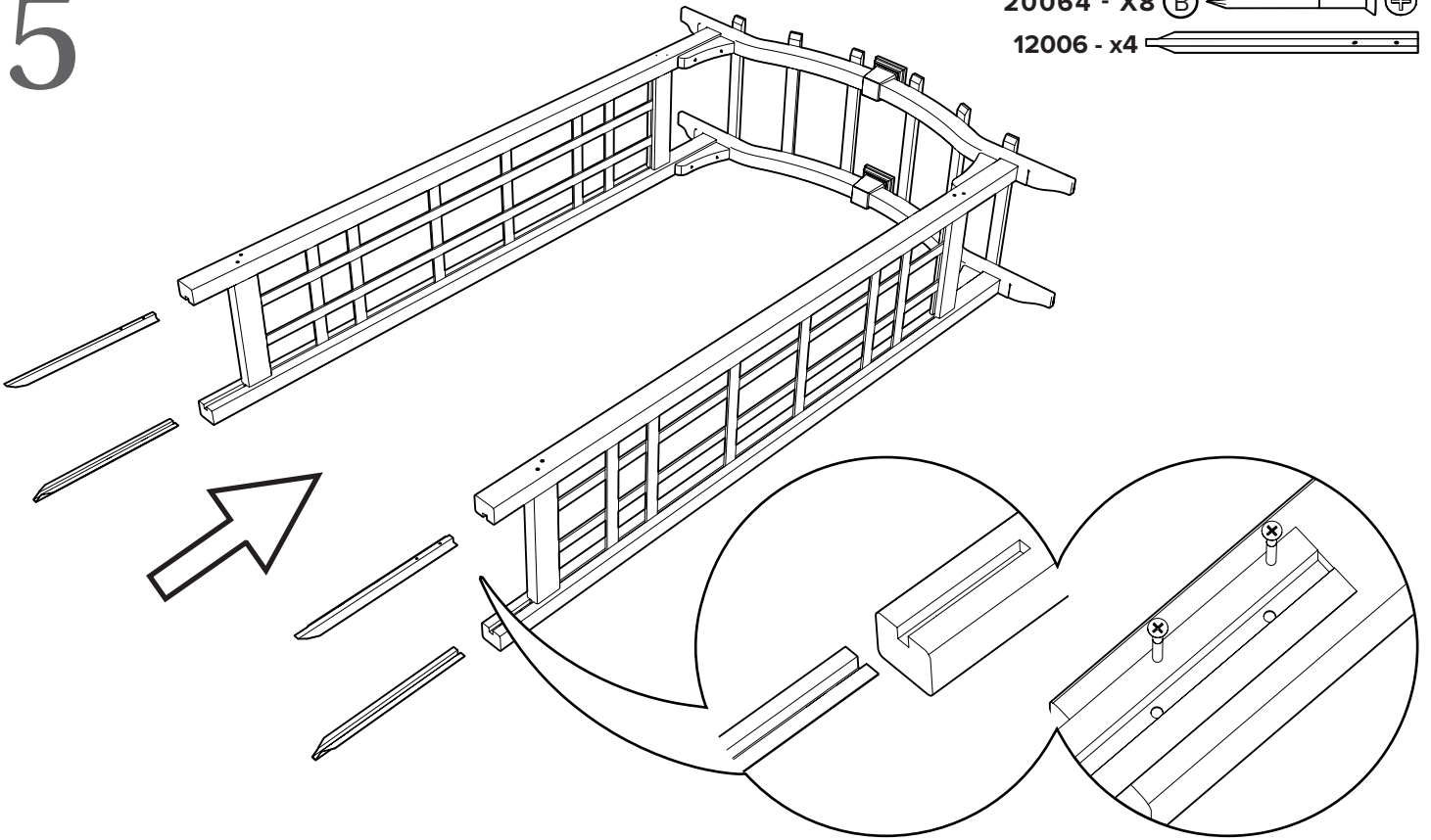

6

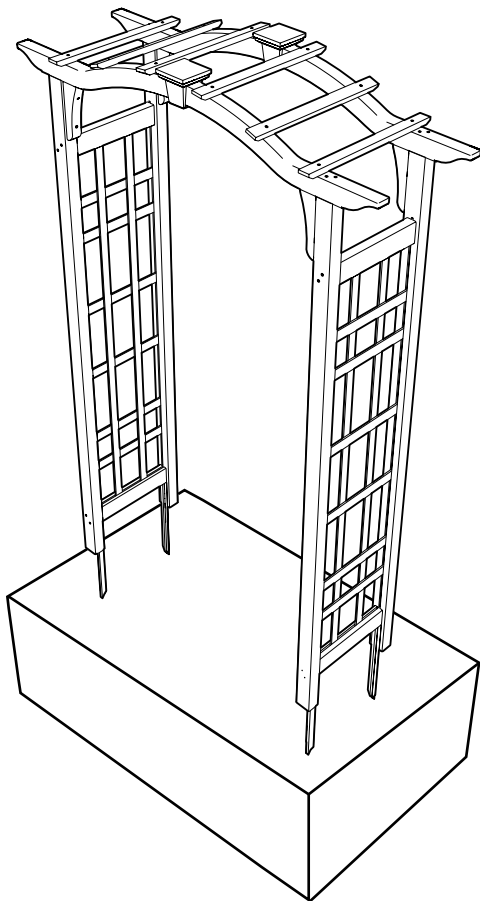

A

Temporary Installation

Carefully push arbor
stakes into desired
ground area

7

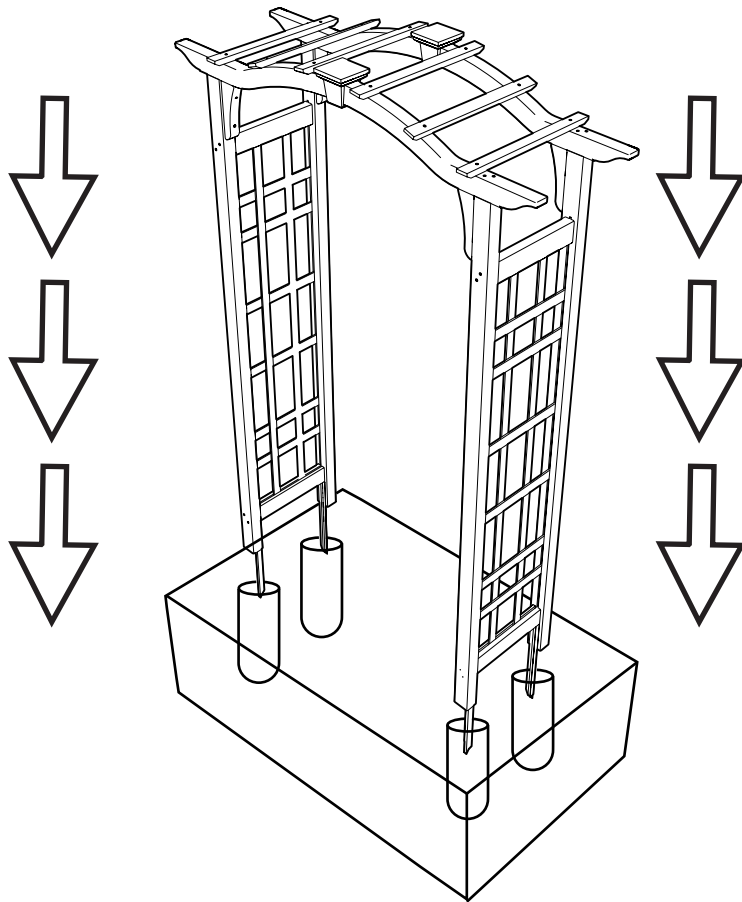

B

Permanent Installation

For a permanent installation, measure four 8in holes in diameter, 44 1/2in (113cm) apart by 15 1/2in (39.4cm), from center to center. Dig each hole 14in (36cm) deep.

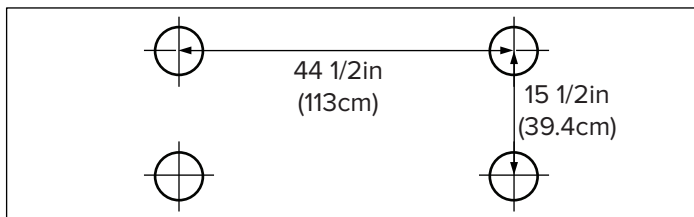

Fill excavated holes with mixed concrete and carefully lift arbor into place. Plumb and level the arbor.

The posts should not be set in the concrete.

Make sure to support bottom part of lattice with bricks until concrete has set. This will stop your arbor from sinking.

