

## High quality aluminum window awnings



Prices are in CAN\$



High quality casement  
aluminum window awning

## The Series 4100 Aluminum Window Awning...

TO ORDER:

STEP #1 - Choose the size - [Series 4100 Window Awning Measure info](#)

STEP #2 - Choose the color - Available in [13 colors](#)

STEP #3 - Information & Orders Call **1-800-922-4760**

All Orders are:



- Partially Assembled, ready to install
- **Delivery Included** - UPS PREPAID
- Delivered within 3 - 4 weeks
- All Pricing is in CAN\$

- Shelter your window from the elements
- Reduces summer cooling costs up to 20% and helps protects your furnishings.
- Sturdy and built to last
- Designed for crank out windows of 18" or less
- 2-coat baked on enamel finish for lasting performance
- Heavy-duty extruded mill-finish framework with reinforced center mullions on all sizes
- Shipped partially assembled with all necessary assembly hardware - complete instructions included
- Orders are not returnable so please verify all information before ordering and take all measurements twice!
- Minor assembly required - comes with all hardware and easy to follow instructions.

-  Available in [13 colors - CLICK HERE](#)

- **PRICING INSTRUCTIONS:** Your awning is made to the inch. Measure the size you need. If it falls between widths on the pricing table simply price it out to the next highest price level. Get the size you need!

	Series #4100 Aluminum Casement Window Awning			
	Model #6	Model #7	Model #8	Model #9
Projection - -	30"	32"	35"	38"
Drop - -	20"	26"	29"	36"
<b>Frame Width</b>	<b>\$CAN</b>	<b>\$CAN</b>	<b>\$CAN</b>	<b>\$CAN</b>
<b>24" - 36"</b>	\$170.00	\$175.00	\$198.00	\$222.00
<b>42"</b>	\$182.00	\$187.00	\$210.00	\$233.00
<b>48"</b>	\$193.00	\$198.00	\$222.00	\$245.00
<b>54"</b>	\$205.00	\$210.00	\$233.00	\$256.00
<b>60"</b>	\$217.00	\$222.00	\$245.00	\$268.00
<b>66"</b>	\$228.00	\$233.00	\$256.00	\$280.00
<b>72"</b>	\$240.00	\$245.00	\$268.00	\$292.00
<b>78"</b>	\$251.00	\$256.00	\$280.00	\$304.00
<b>84"</b>	\$263.00	\$268.00	\$292.00	\$315.00

 We accept VISA, MasterCard and PayPal payments  
 OR get a 5% discount by sending a Certified Cheque.  
 Please note special or custom orders not returnable.

**For Information or to order**  
**CALL (800) 922-4760**

## How to Measure... for the Series 4100 Casement Aluminum Window Awning

Aluminum Window Awnings make a better home. After you install your window awning, add a door canopy kits for shade, or retractable awning kits for sun protection. Window Awnings offer great sun protection or protection from the elements for any window on the home. Trust us for quality products at discounted prices.

**Step-1:** Choose the DROP & PROJECTION, using the chart below, that best suits your needs. This will determine how far down the window the awning will come. The DROP associated with the "Window Height" (A) is only a suggestion. You may choose any of the drops within the table you wish. Casement awnings require a minimum of 6" above the window for mounting. Windows opening more than 18" will require additional mounting space.

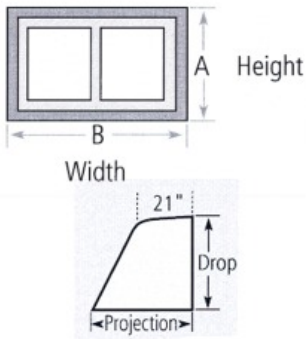

**Step-2:** Measure outside of window casing - edge to edge (B). If you mount the awning on the window casing (frame), this measurement is what you need. If you wish to mount the awning on the house wall then you need to add, at least, 1-1/2" on to each side to determine the final measurement. Awnings **cannot** be mounted on shutters.

**Step-3: Color and Pattern Choices:**

[Select color](#) & pattern that best compliments your home, from our selection.

1. Available in solid or striped pattern (No additional cost)
2. Sides are available in solid color only (Series 4500)
3. Undersides of all aluminum canopies are white only

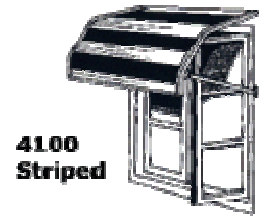
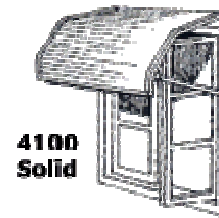

Note: Get the width you need going up in 1" increments.

Awning Model #	6	7	8	9
For Window Heights of:	46"	56"	66"	76"
Projection	27"	30½"	33½"	36½"
Drop Approx.	20½"	26"	31"	36½"

**Step-4: To Order - Call 1-800-922-4760 with the following information**

	Step-1	Step-2	Step-3	
Quantity	Series 4100 Window Awning Model#	Awning Width	Base Colour	Accent Colour

Obtaining necessary permits is the sole responsibility of purchaser. Customers agree to hold ScreenHouses Unlimited and manufacturer free of any liability for improper installation, maintenance and repair.

**All Prices in Canadian Dollars. Delivery to major centres in Canada is FREE! No Extra Charges! No Silly Fees! Only applicable taxes are extra.**

 We accept VISA, MasterCard and PayPal payments  
OR get a 5% discount by sending a Certified Cheque.  
Please note special or custom orders not returnable.

**For Information or to order  
CALL (800) 922-4760**